

120mm x 120mm Mounting Stage Size, Metric Z-Axis Stage



Stock #62-299 **7 In Stock**

⊖ 1 ⊕ €1.195⁰⁰

ADD TO CART

Volume Pricing

Qty 1-4	€1.195,00 each
Qty 5+	€1.056,50 each
Need More?	Request Quote

ⓘ Prices shown are exclusive of VAT/local taxes

Product Downloads

General

Metric **Type:**

Physical & Mechanical Properties

Linear (Z) **Type of Movement:**

Crossed Roller Bearing **Guide System:**

120 x 120	Stage Size (mm):
M16 x 1	Center Hole:
Aluminium Stage	Construction:
±10	Height Adjustment (mm):
7	Load Capacity (kg):
(4) 4.5mm Diameters on 100mm Sq.	S.H.C.S. C'bore:
3	Straight Line Accuracy (µm):
0.5	Travel Per Knob Rotation (mm):
1.42	Weight (kg):

Hardware & Interface Connectivity

Metric Micrometer	Type of Drive:
-------------------	-----------------------

Threading & Mounting

(1) M16 x 1, (12) M4 x 0.7	Mounting Threads:
----------------------------	--------------------------

Regulatory Compliance

Exempt	RoHS 2015:
View	Certificate of Conformance:
Contains SVHC(s)	Reach 247:

Product Details

- Fine Micrometer Movement
- Available in Four Sizes
- Black Anodized Aluminum
- Locking Knob

Metric Z-Axis Stages provides micrometer movement for optical components. One rotation of the knob equals 0.5mm. Height adjustment is ±2.5mm for 25mm and 40mm stages and ±5.0mm for 60mm and 80mm stages. Metric Z-Axis Stages are available are constructed of black anodized aluminum and feature a locking knob. The stages are available in four sizes.

40mm square, 8mm thick top mounting adapter plate [#58-290](#) mounts to M3 holes and provides a counterbore for 1/4-20 or M6 socket head cap screw. Compatible with the following stages: [#55-029](#), [#55-030](#), [#55-031](#), [#55-838](#), and [#55-839](#).

60mm square Z-Axis Stage ([#55-032](#)) and 80mm square Z-Axis Stage ([#56-335](#)) are compatible with the following stages: [#54-687](#), [#55-459](#), [#55-840](#), [#55-841](#), and [#56-335](#).

Technical Information

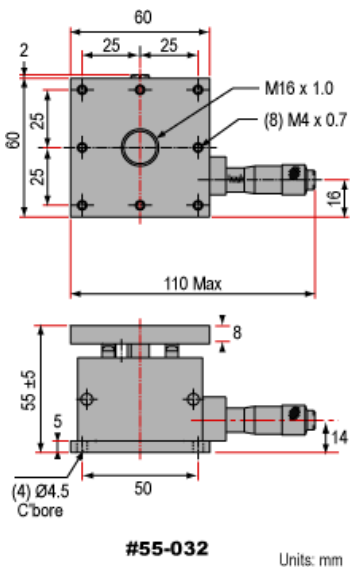

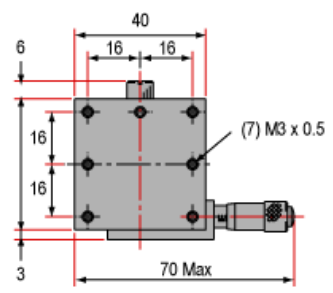

#55-031

Units: mm

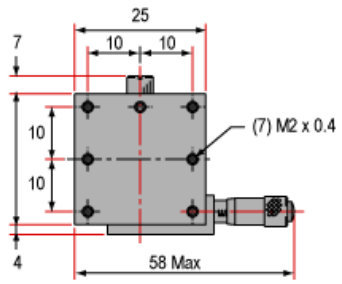

#56-334

Units: mm

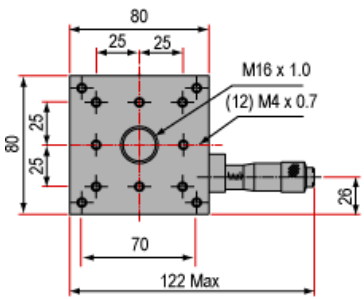

#56-335

Units: mm

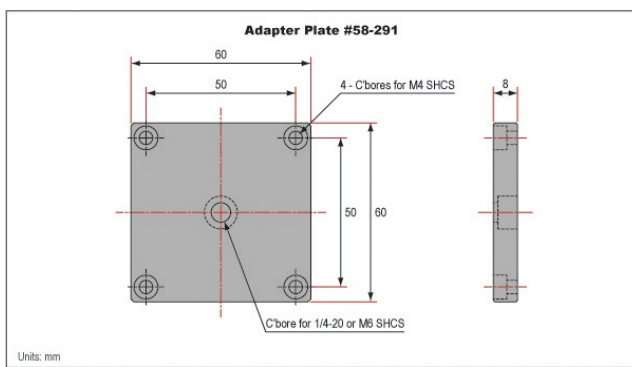

Units: mm