

[See all 195 Products in Family](#)

TECHSPEC® 25.4mm Dia. x 50mm FL, 355nm Coated, Laser Grade PCX Lens



TECHSPEC Laser Grade PCXLenses

Stock **#38-672 1 In Stock**

[Other Coating Options](#)

⊖ 1 ⊕ €231⁰⁰

ADD TO CART

Volume Pricing	
Qty 1-5	€231,00 each
Qty 6-25	€185,00 each
Qty 26-49	€169,00 each
Need More?	Request Quote

! Prices shown are exclusive of VAT/local taxes

Product Downloads

General

Plano-Convex Lens **Type:**

Physical & Mechanical Properties

25.40 +0.00/-0.025 **Diameter (mm):**

<1	Centering (arcmin):
6.35 ±0.10	Center Thickness CT (mm):
2.35	Edge Thickness ET (mm):
21.59	Clear Aperture CA (mm):
Protective as needed	Bevel:

Optical Properties

50.00 @ 355nm	Effective Focal Length EFL (mm):
45.71	Back Focal Length BFL (mm):
Laser V-Coat (355nm)	Coating:
R _{abs} <0.25% @ 355nm	Coating Specification:
Fused Silica (Corning 7980)	Substrate: <input type="checkbox"/>
10-5	Surface Quality:
λ	Power (P-V) @ 632.8nm:
M10	Irregularity (P-V) @ 632.8nm:
±1	Focal Length Tolerance (%):
23.80	Radius R ₁ (mm):
1.97	f##:
0.25	Numerical Aperture NA:
355	Design Wavelength DWL (nm):
7.5 J/cm ² @ 355nm, 20ns, 20Hz	Damage Threshold, By Design: <input type="checkbox"/>

Regulatory Compliance

Compliant	RoHS 2015:
Compliant	Reach 209:
View	Certificate of Conformance:

Need different specs or modifications?

Edmund Optics offers comprehensive custom manufacturing services for optical and imaging components tailored to your specific application requirements. Whether in the prototyping phase or preparing for full-scale production, we provide flexible solutions to meet your needs. Our experienced engineers are here to assist—from concept to completion.

Our capabilities include:

- Custom dimensions, materials, coatings, and more
- High-precision surface quality and flatness
- Tight tolerances and complex geometries
- Scalable production—from prototype to volume

Learn more about our [custom manufacturing capabilities](#) or submit an inquiry [here](#).

Product Details

- Guaranteed Laser Damage Threshold
- 10-5 Surface Quality
- M10 Surface Accuracy

TECHSPEC® Laser Grade PCX Lenses are designed for high energy Nd:YAG laser applications including laser cutting, machining, and welding. The precision fused silica substrate, featuring M10 surface accuracy and 10-5 surface quality, ensures low scatter and excellent transmitted wavefront performance. TECHSPEC® Laser Grade PCX Lenses are available uncoated or with a variety of high laser damage threshold anti-reflection (AR) coating options. Coatings are available at the most common Nd:YAG laser wavelengths to ensure maximum laser throughput.



Technical Information

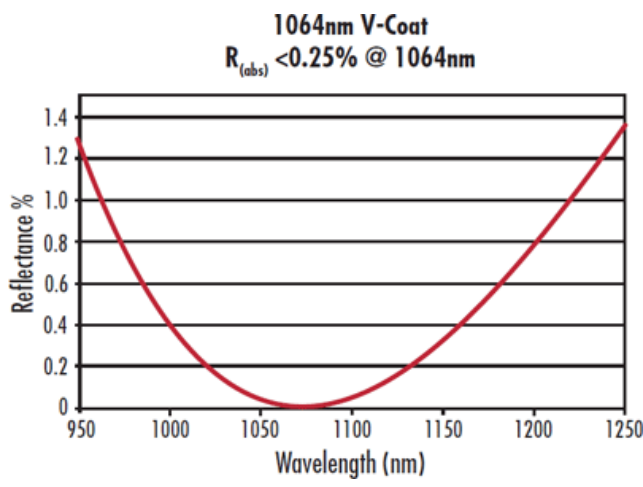
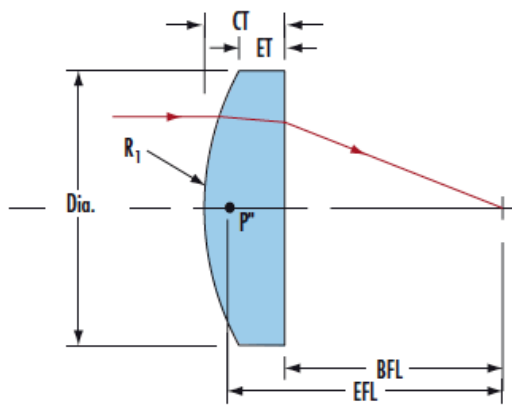
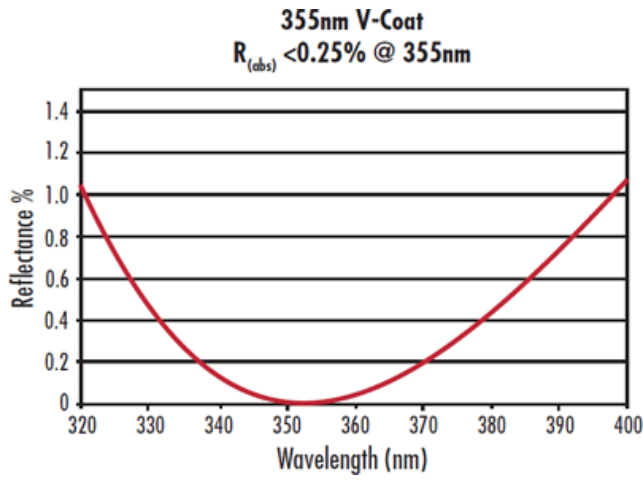
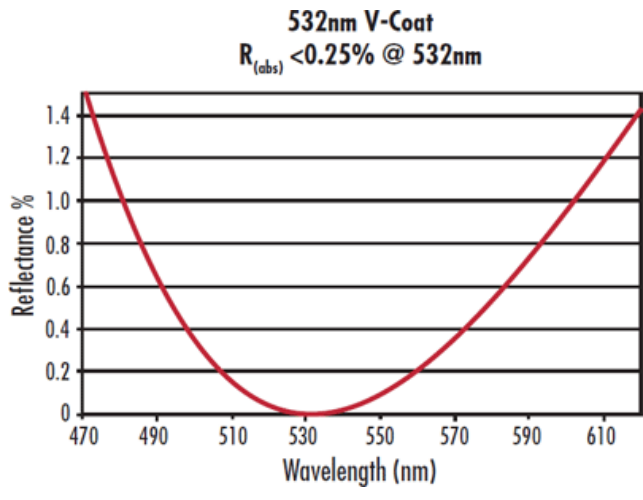

Compatible Mounts