

[See all 27 Products in Family](#)

TECHSPEC® 25mm Dia. x 30mm FL, BBAR (1650-3000nm) Coated, Si Plano-Convex Lens



Stock **#21-089** **2 In Stock**

[Other Coating Options](#)

⊖ 1 ⊕ €266.⁰⁰

ADD TO CART

Volume Pricing	
Qty 1-5	€266,00 each
Qty 6-25	€227,00 each
Qty 26-49	€201,00 each
Need More?	Request Quote

! Prices shown are exclusive of VAT/local taxes

Product Downloads

General

Plano-Convex Lens **Type:**

Physical & Mechanical Properties

25.00 +0.0/-0.1 **Diameter (mm):**

Centering (arcmin):

Center Thickness CT (mm):
3.50 ±0.10

Edge Thickness ET (mm):
2.41

Clear Aperture CA (mm):
24

Bevel:
Protective as needed

Optical Properties

Effective Focal Length EFL (mm):
30.00 @ 10.6µm

Back Focal Length BFL (mm):
28.98

Coating:
BBAR (1650-3000nm)

Coating Specification:
R_{avg} <1% @ 1650 - 3000nm
R_{abs} <2% @ 1650 - 3000nm

Substrate:
Silicon (Si)

Surface Quality:
60-40

Power (P-V) @ 632.8nm:
2λ

Irregularity (P-V) @ 632.8nm:
λ/2

Radius R₁ (mm):
72.53

f#:
1.2

Numerical Aperture NA:
0.42

Wavelength Range (nm):
1650 - 3000

Regulatory Compliance

RoHS 2015:
[Compliant](#)

Certificate of Conformance:
[View](#)

Reach 235:
[Compliant](#)

Need different specs or modifications?

Edmund Optics offers comprehensive custom manufacturing services for optical and imaging components tailored to your specific application requirements. Whether in the prototyping phase or preparing for full-scale production, we provide flexible solutions to meet your needs. Our experienced engineers are here to assist—from concept to completion.

Our capabilities include:

- Custom dimensions, materials, coatings, and more
- High-precision surface quality and flatness
- Tight tolerances and complex geometries
- Scalable production—from prototype to volume

Learn more about our [custom manufacturing capabilities](#) or submit an inquiry [here](#).

Product Details

- Wavelength Range of 1.2 - 7µm
- Low Density and Dispersion
- Focal Lengths of 25 – 250mm Available
- Additional [Infrared Lenses](#) Available in Popular Substrates

Our TECHSPEC® Silicon Plano-Convex (PCX) Lenses feature precision polished surfaces, making them ideal for a variety of infrared applications, including Near-Infrared (NIR) imaging, and infrared spectroscopy. Available in a variety of focal lengths from f/1 thru f/10, the lenses are offered uncoated or broadband anti-reflection coated. For more information on Silicon properties, please review our guide to selecting [The Correct Material for Infrared \(IR\) Applications](#).

Technical Information

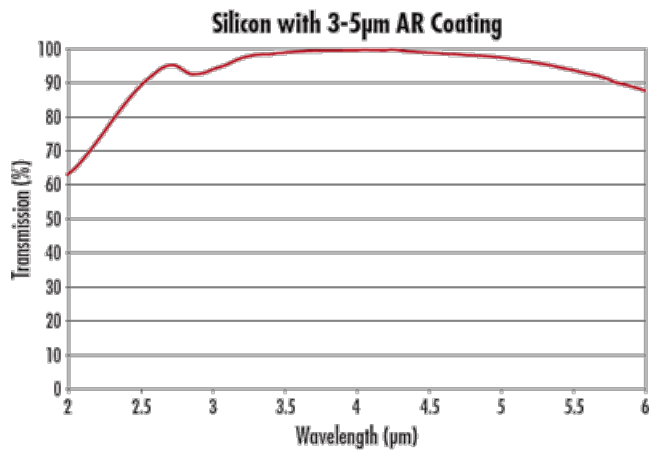
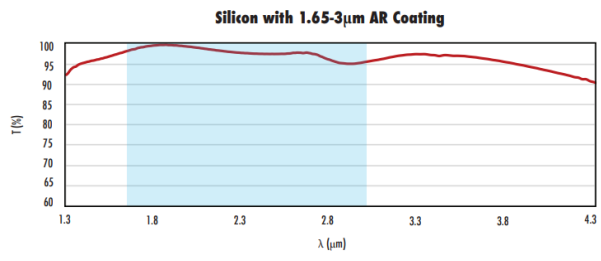
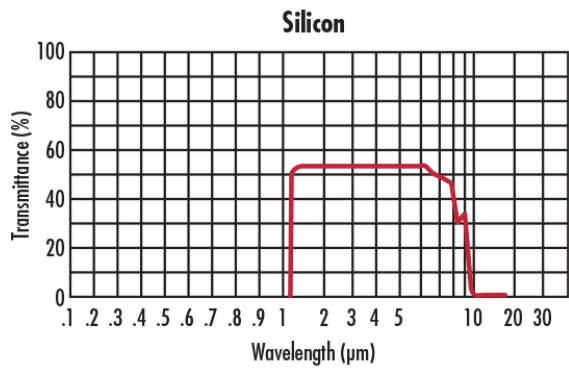
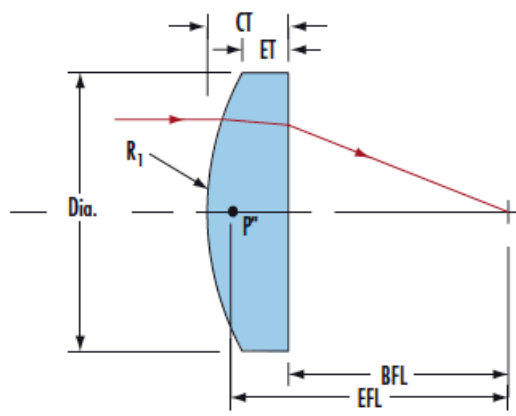

Compatible Mounts