

[See all 20 Products in Family](#)

## 40.0mm Optic Dia., Optic Mount



Optic Component Mounts

Stock #64-566 **15 In Stock**

⊖ 1 ⊕ €32<sup>75</sup>

**ADD TO CART**

### Volume Pricing

Qty 1-9	€32,75 each
Qty 10+	€29,60 each
Need More?	<a href="#">Request Quote</a>

ⓘ Prices shown are exclusive of VAT/local taxes

### Product Downloads

#### General

Fixed **Type:**

Circular **Type of Optics:**

#### Physical & Mechanical Properties

36.0 **Clear Aperture CA (mm):**

60.0	Outer Diameter (mm):
18.00	Thickness (mm):
Black Anodized Aluminum	Construction:
12.00	Max. Thickness of Compatible Optics (mm):

### Threading & Mounting

40.0	Size of Compatible Optics (mm):
M6 x 1.0, 1/4-20	Compatible Post:

### Regulatory Compliance

<a href="#">Compliant</a>	RoHS 2015:
<a href="#">View</a>	Certificate of Conformance:
<a href="#">Compliant</a>	Reach 247:

## Product Details

- Simple Mounting Arrangement
- Metric and English Configurations
- Black Anodized Aluminum Construction
- [Posts](#) and [Post Holders](#) Required for Mounting

Optic Component Mounts are designed to hold lenses, filters, mirrors, and other optical components. The included retainer ring securely holds the component in place. Optic Component Mounts need the required [posts](#) and [post holders](#) for mounting to a breadboard. Both English (1/4-20) and Metric (M6) standard posts are accepted by the mounts. These mounts are constructed of black anodized aluminum in a simple mounting arrangement.

## Technical Information

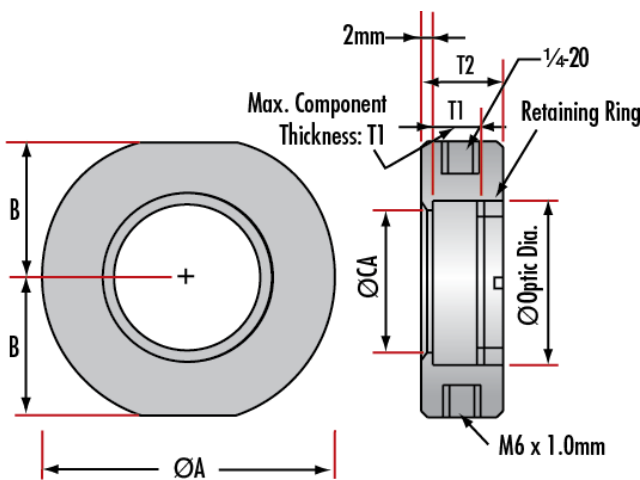

Maximum Optic Diameter	Clear Aperture (CA)	Mount Diameter A	B	Maximum Optic Thickness T1	Mount Thickness T2	Stock No.
5	4	30	13.5	5.7	12	<a href="#">#64-551</a>
6	5	30	13.5	5.7	12	<a href="#">#64-552</a>
9	6	30	13.5	6	12	<a href="#">#64-553</a>
10	7	30	13.5	6	12	<a href="#">#64-554</a>
12	9	35	16.0	10	16	<a href="#">#64-555</a>
12.7	9.5	35	16.0	10	16	<a href="#">#64-556</a>
15	12	35	16.0	10	16	<a href="#">#64-557</a>
18	15	40	19.0	12	18	<a href="#">#64-558</a>
20	17	40	19.0	12	18	<a href="#">#64-559</a>
25	22	45	21.5	10	16	<a href="#">#64-560</a>
25.4	22	45	21.5	10	16	<a href="#">#64-561</a>
25.4	22	45	21.5	13	19	<a href="#">#65-562</a>
30	26	50	24.0	6	12	<a href="#">#64-563</a>
30	26	50	24.0	12	18	<a href="#">#64-564</a>
38.1	34	60	29.0	12	18	<a href="#">#64-565</a>
40	36	60	29.0	12	18	<a href="#">#64-566</a>
50	46	70	34.0	12	18	<a href="#">#64-567</a>
50	46	70	34.0	18	24	<a href="#">#64-568</a>
50.8	46	70	34.0	12	28	<a href="#">#64-569</a>

