

[See all 76 Products in Family](#)

TECHSPEC® 6mm, f/8 Ci Series Fixed Focal Length Lens



6mm Focal Length

Stock #86-596 **20+ In Stock**

⊖ 1 ⊕ €285⁰⁰

ADD TO CART

Volume Pricing

Qty 1-24	€285,00 each
Qty 25+	€257,00 each
Need More?	Request Quote

ⓘ Prices shown are exclusive of VAT/local taxes

Product Downloads

General

Ci Series **Product Family:**
Fixed Focal Length Lens **Type:**

Physical & Mechanical Properties

Fixed **Iris Option:**

47.80	Length (mm):
34	Maximum Diameter (mm):
34	Outer Diameter (mm):
64	Weight (g):
1.17	Maximum Rear Protrusion (mm):
26.50	Diameter (mm):

Optical Properties

110.2mm - 62.1°	Horizontal Field of View @ Max Sensor Format:
Horizontal: 110mm - 62.1° Vertical: 80.4mm - 47.8° Diagonal: 141.9mm - 75°	Field of View at Max Sensor Format:
110.2mm - 62.1°	Horizontal Field of View, 1/1.8" Sensor:
96.8mm - 55.9°	Horizontal Field of View, 1/2" Sensor:
86.9mm - 51.0°	Horizontal Field of View, 1/2.5" Sensor:
71.0mm - 42.7°	Horizontal Field of View, 1/3" Sensor:
52.6mm - 32.4°	Horizontal Field of View, 1/4" Sensor:
9.00	Maximum Image Circle (mm):
0.0043	Numerical Aperture NA, Object Side:
9 (7)	Number of Elements (Groups):
6.00	Focal Length FL (mm):
75 - ∞	Working Distance (mm):
f/8	Aperture (f/#):
425 - 675nm BBAR	Coating:
425 - 675nm BBAR	Coating Specification:
16.08	Entrance Pupil Position (mm):
21.35	Object Space Principal Plane (mm):
6.60	Image Space Principal Plane (mm):
-6.82	Maximum Distortion (%):
-25.52	Exit Pupil Position (mm):
VIS	Lens Wavelength Range:

Sensor

1/1.8"	Maximum Sensor Format:
2.74	Pixel Size (µm):

Threading & Mounting

M43 x 0.75 (Female)	Filter Thread:
#89-940 (Required)	Filter Thread Adapter:
M34.0 x 0.5 (Male)	Front Thread:
C-Mount	Mount:

Environmental & Durability Factors

Storage Temperature (°C):

-20 to +60

Type of Ruggedization:

Industrial (Fixed Aperture with Simplified Mechanics)

Regulatory Compliance

RoHS 2015:

Compliant

REACH 201:

Compliant

Certificate of Conformance:

[View](#)

Product Details

These compact lenses are designed specifically for volume integration into applications such as analytical medical devices, including benchtop-based blood analyzers. For customized $f\#$ versions to best suit your instrumentation application needs and to discuss volume requirements, please [contact us](#).

- Up to 2/3", C-Mount Lens
- Up to 7.5 MegaPixels, 2.8 μ m Pixel Size Sensors
- Instrumentation (Ci) Versions of our C Series Lenses with Streamlined Mechanical Designs and Fixed Apertures
- 3.5mm to 50mm Focal Length
- [Ruggedized \(Cr\) Designs](#) Also Available

TECHSPEC® Ci Series Fixed Focal Length Lenses are a streamlined version of our C Series Fixed Focal Length Lenses. They feature the same low lens-to-lens variation and broadband anti-reflection (BBAR) coating for maximum light transmission, while offering reduced weight and size. An adjustable, lockable focus allows for setting and locking the best focus position for instrumentation integration. TECHSPEC® Ci Series Fixed Focal Length Lenses are designed specifically for volume integration into applications such as factory inspection and automation to benchtop biomedical devices. The Ci Series offers a wide range of aperture options, ensuring maximum flexibility of resolution, throughput, and depth of field.

Edmund Optics has created a family of high performance optical designs (the C Series family) and developed 6 customized optomechanical solutions targeted for specific applications. These lens sub-families utilize the same optics as the C Series lenses providing the same optical performance in a variety of optomechanical solutions to meet your application requirements:

- **C Series:** Features locking cam focus and iris adjustment and is the most adjustable version of these optical designs; they are the typical high quality machine vision lenses. Also available with a [VIS-NIR Broadband Anti-Reflection \(BBAR\) Coating](#).
- **Ci Series:** Simplified mechanics featuring fixed apertures with compact housing. [Industrial Ruggedization](#) for reduced size, cost, and locked focus.
- **Cr Series:** All optics glued in place and a locking C-clamp focus ring. [Stabilized Ruggedization](#) for reduced pixel shift and improved focus stability.
- **Cx Series:** Modular, flexible mechanics allows lenses to be taken apart for easy integration of accessories such as liquid lenses, apertures, and more.
- **Liquid Lens Cx Series:** Designed with an integrated liquid lens for quick autofocus.
- **Cw Series:** Waterproof, designed to meet IEC [Ingress Protection](#) Code IPX7 and IPX9K.

Technical Information

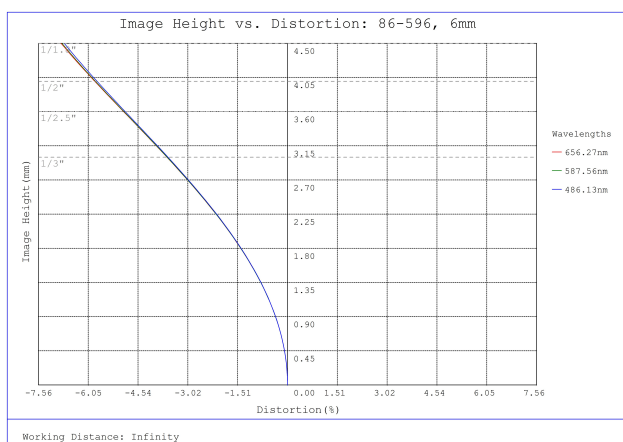

#86-596, 6mm, $f/8$ Ci Series Fixed Focal Length Lens, Distortion Plot

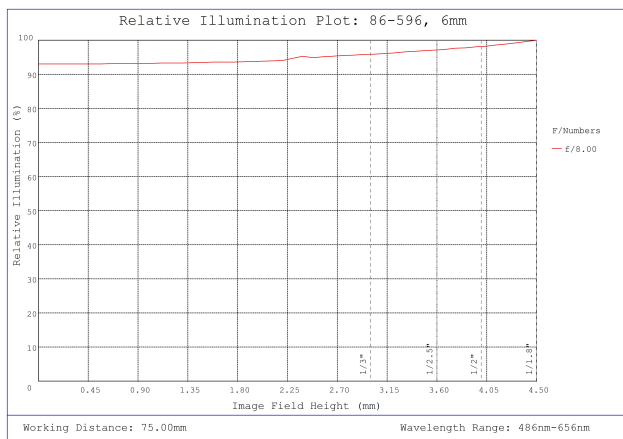

#86-596, 6mm, $f/8$ Ci Series Fixed Focal Length Lens, Relative Illumination Plot

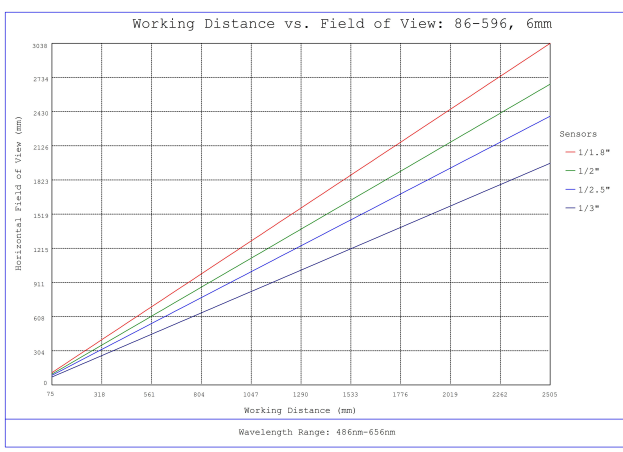

#86-596, 6mm, f/8 Ci Series Fixed Focal Length Lens, Working Distance versus Field of View Plot

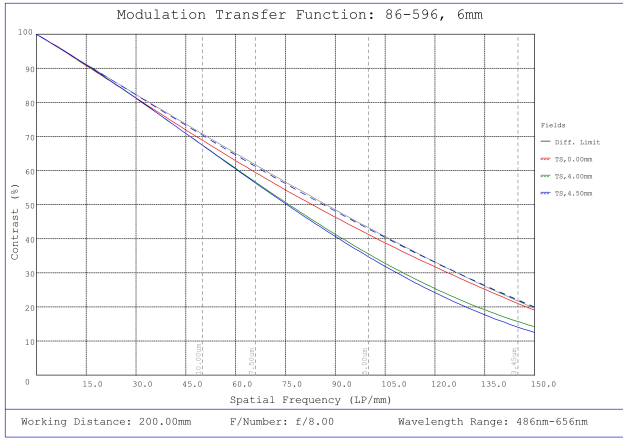

#86-596, 6mm, f/8 Ci Series Fixed Focal Length Lens, Modulated Transfer Function (MTF) Plot, 200mm Working Distance, f8

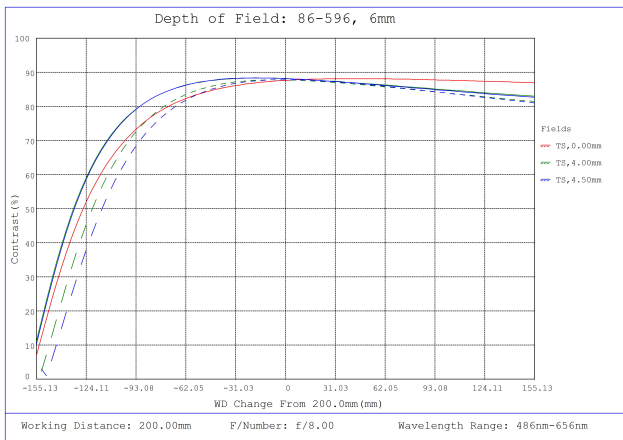

#86-596, 6mm, f/8 Ci Series Fixed Focal Length Lens, Depth of Field Plot, 200mm Working Distance, f8

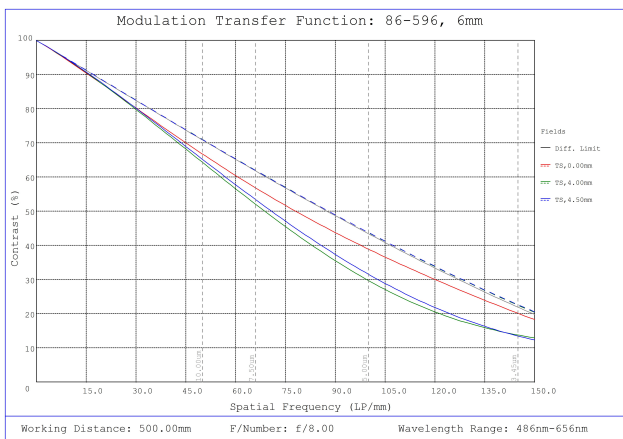

#86-596, 6mm, f/8 Ci Series Fixed Focal Length Lens, Modulated Transfer Function (MTF) Plot, 500mm Working Distance, f8

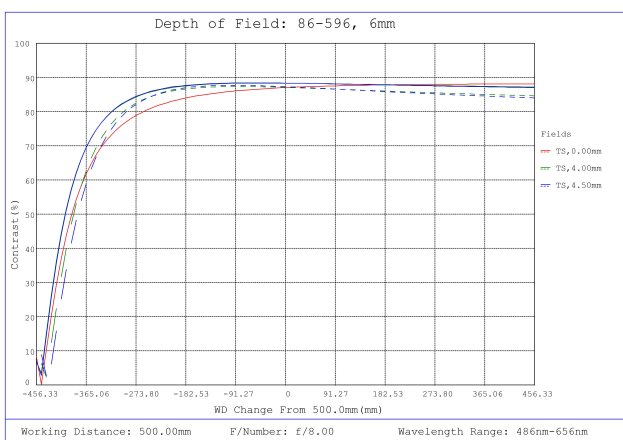

#86-596, 6mm, f/8 Ci Series Fixed Focal Length Lens, Depth of Field Plot, 500mm Working Distance, f8

Focal Length	A	B	C	D
6mm	M34.0 x 0.5	47.8mm	34mm	1.17mm
12mm	M22.0 x 0.75	29.0mm	22mm	0.96mm
16mm	M22.0 x 0.75	40.8mm	22mm	1.09mm
25mm	M22.0 x 0.75	29.9mm	22mm	1.33mm
35mm	M25.5 x 0.5	41mm	22.5mm	3.82mm
50mm	M30.5 x 0.5	49.5mm	30.5mm	2.06mm

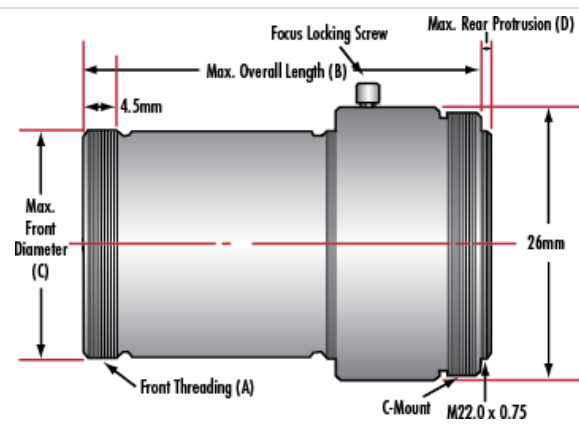

Compatible Cameras