

[See all 10 Products in Family](#)

Glan-Thompson Polarizer 350 - 2200nm, 8mm



Glan-Thompson Polarizer

Stock **#89-544** [CONTACT US](#)

⊖ 1 ⊕ €790⁰⁰

ADD TO CART

Volume Pricing	
Qty 1-5	€790,00 each
Qty 6+	€755,00 each
Need More?	Request Quote

ⓘ Prices shown are exclusive of VAT/local taxes

Product Downloads

General

Linear Polarizer **Type:**

Physical & Mechanical Properties

8.0 **Clear Aperture CA (mm):**

25.40 **Diameter (mm):**

28.00 Length (mm):

Crystalline Glan-Thompson Polarizer Construction:

Optical Properties

Single Layer MgF₂ Coating:

<5 x 10⁻⁵ Extinction Ratio:

Calcite Substrate:

20-10 Surface Quality:

λ/2 @ 632.8nm Transmitted Wavefront, P-V:

<3 Beam Deviation (arcmin):

λ/4 @ 632.8 nm Transmitted Wavefront Distortion (RMS):

350 - 2200 Wavelength Range (nm):

1 J/cm² @ 1064nm, 10ns, 10Hz Damage Threshold, By Design:

Regulatory Compliance

Compliant RoHS 2015:

View Certificate of Conformance:

Compliant Reach 247:

Product Details

- High Extinction Ratios up to 200 000:1
- High Laser Damage Thresholds up to 5 J/cm² @ 1064nm

Glan-Type Polarizers are mounted, polarizing prisms used in applications that require broad spectral ranges, high extinction ratios, or high polarization purities. Glan-Taylor Polarizers are medium-power, air-spaced UV to NIR polarizers that transmit the extraordinary beam. The ordinary beam is then reflected and absorbed by black glass plates that have been cemented to the prism. Glan-Laser Polarizers are similar to Glan-Taylor, but are designed for higher power applications and appropriate for use in Q-switched laser cavities. Glan-Laser Polarizers utilize an advanced polishing technique for minimizing surface scatter and feature two escape windows for passing the high power rejected light. Glan-Thompson Polarizers are low power polarizers that are ideal for UV, visible, or NIR applications, feature a cemented design, and transmit the extraordinary beam while absorbing the reflected ordinary beam.

LASER OPTICS MADE BY EDMUND OPTICS®

[LEARN MORE](#)

Technical Information

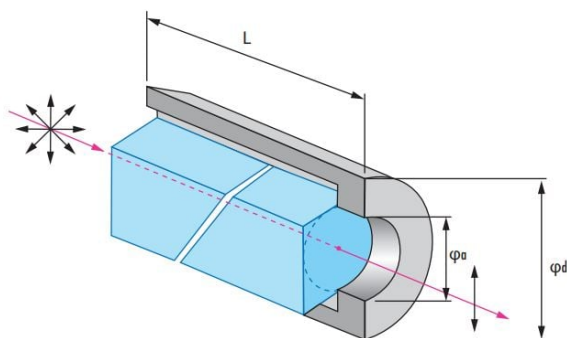

Glan-Taylor Polarizers



Glan-Laser Polarizers



Glan-Thompson Polarizers