

[See all 16 Products in Family](#)

Olympus UPLXAPO 4X Objective

See More by [Olympus](#)



Olympus UPLXAPO 4X Objective, #14-905

Stock **#14-905** **5 In Stock**

⊖ 1 ⊕ €2.540⁰⁰

ADD TO CART

Volume Pricing	
Qty 1+	€2.540,00 each
Need More?	Request Quote

ⓘ Prices shown are exclusive of VAT/local taxes

Product Downloads

General

UPLXAPO4X **Model Number:**

Compatible Tube Lens Focal Length (mm):
Focal Length: 180mm

Microscope Objective **Type:**

Infinity Corrected **Style:**

Olympus
Manufacturer:

Physical & Mechanical Properties

Field of View (mm):
6.63

Length excluding Threads (mm):
32.06

Maximum Diameter (mm):
28

Weight (g):
107

Optical Properties

Compatible Cover Glass Thickness (mm):
N/A

Focal Length FL (mm):
45.00

Magnification:
4X

Numerical Aperture NA:
0.16

Resolving Power (μm):
2.1

Depth of Field (μm):
10.74

Working Distance (mm):
13.0

Wavelength Range (nm):
400 - 1000

Field Number (mm):
26.5

Parfocal Length (mm):
45.06

Immersion Liquid:
N/A

Entrance Pupil Diameter (mm):
14.40

Threading & Mounting

Mounting Threads:
RMS / 20.32mm x 36 TPI

Regulatory Compliance

Certificate of Conformance:
[View](#)

Product Details

- High Numerical Aperture (NA) up to 1.45
- Chromatic Aberration Correction from 400 - 1000nm
- Uniform Image Flatness over Large FOVs

Olympus X-Line Extended Apochromat Infinity Corrected Objectives (also referred to as the UPLXAPO series) are Olympus' next generation high performance objectives that simultaneously feature high numerical aperture (NA), broadband chromatic aberration correction, and excellent image flatness. The high numerical aperture (NA) allows for excellent light collection efficiency to better capture faint signals, enabling a shorter exposure time and higher contrast. The broad chromatic aberration correction compensates for the wavelength-dependent spatial shift of colors to achieve excellent color reproduction. These objectives also achieve high image flatness from the center to the edges of images over large fields of view (FOV), making them ideal for image stitching and quantitative image analysis. Olympus X-Line Extended Apochromat Infinity Corrected Objectives are used in demanding life science and clinical applications including pathology, fluorescence microscopy, multicolor or widefield fluorescence imaging, confocal or super resolution microscopy, and whole slide imaging.

Technical Information

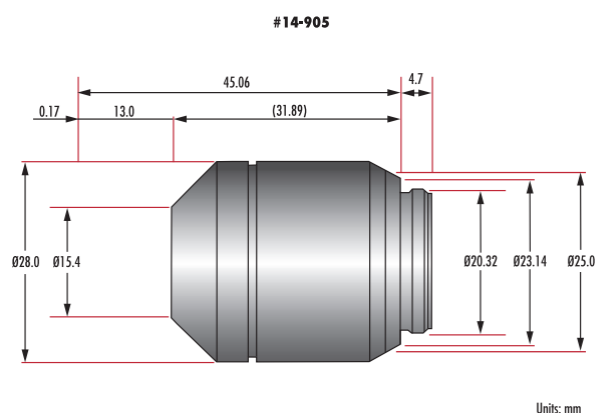

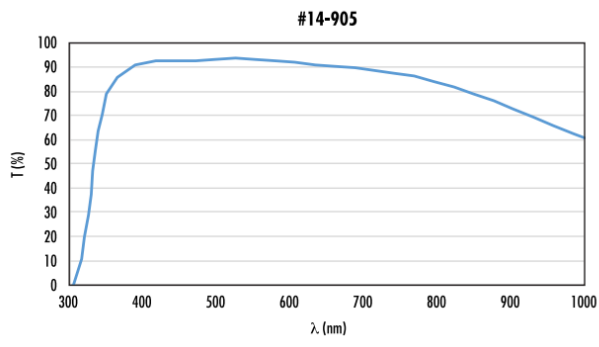

	Stock #	A	B	C	D	E	F	G	WD
Olympus UPLXAPO 4X Objective	#14-905	31.89	-	-	15.4	15.4	28	4.7	13.0
Olympus UPLXAPO 10X Objective	#14-906	41.78	3.7	4.28	9.6	19.4	28	4.6	3.1
Olympus UPLXAPO 20X Objective	#14-907	44.28	3.39	2.88	10.2	18.6	28	4.8	0.61
Olympus UPLXAPO 40X Objective	#14-908	44.71	4.21	2.11	7.5	20.3	31.5	4.9	0.18
Olympus UPLXAPO 60X Oil Immersion Objective	#14-909	44.74	2.1	2.84	10	19.3	31.5	4.9	0.15
Olympus UPLXAPO 100X Oil Immersion Objective	#14-910	44.76	2.1	3.06	7.5	19.1	30.5	4.8	0.135

